

Article number: 20288B50B50T2SW

Description: E+G Swivel clamp - GN 288-B50-B50-T-2-SW

Measures

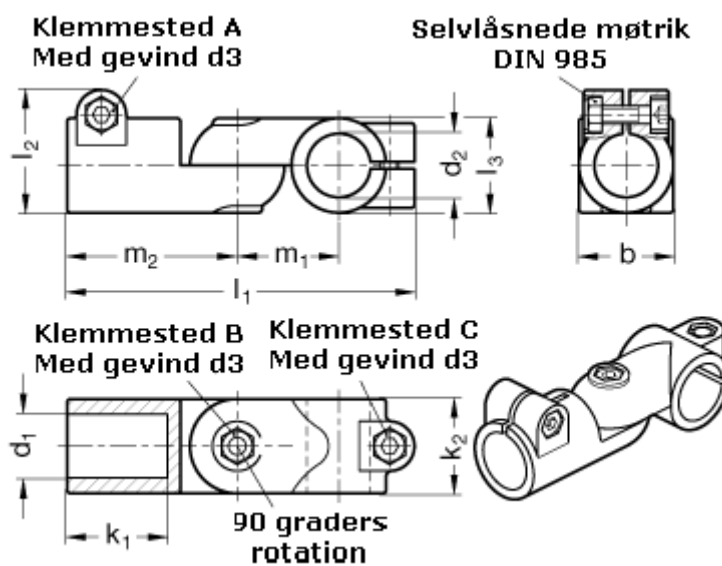

$b = 65$

$d_1 = B50$

$d_2 = B50$

$d_3 = M10$

$k_1 = 74.0$

$k_2 = 65$

$l_1 = 230$

$l_2 = 77.5$

$m_1 = 70$

$m_2 = 115$